

SERIE 900

Code CR0785869 **Model** 90FT/G400



GAS GRIDDLE WITH SMOOTH PLATE TOP VERSION

General characteristics

The 900 BARON line is made in compliance with strict European Standards in terms of safety, hygiene, reliability and respect for the environmental and is certified under international standards such as CE, GOST, AGA and others. Stainless steel with scotch-brite finish heightens the aesthetic appeal, and the technological and ergonomic innovation of this equipment. Thanks to great compositional flexibility,

cook tops can be matched with oven bases and accessorised with hygienic finishes. Customised line-ups are possible by combining and fixing the equipment back to back, flushed sideways with perfectly sealed connections, or by creating "bridge" structures, offering top solutions to any chef. Basic range features:

- 2 mm thick moulded tops;
- 2" height adjustable stainless steel feet;
- removable control panel for access, moulded and shaped to avoid withholding dirt;
- recessed, tilted and ergonomic knobs.



FRY TOP

Excellent for cooking easily digestible dishes in natural ways, the griddle plates are characterized by an extraordinarily temperature uniformity, high production, easy cleaning and maximum reliability over time.

Technical/functional characteristics

- Lowered griddle compared to the 4 cm top and tilted towards the machine front by 1 cm to drain the fat;
- Wide drawer for fat collection;
- Available with soft iron griddle or polished chrome griddle.
- Stable flame burners with piezo-electric ignition
- Independent controls every 40 cm wide module
- Temperature adjustment from 200°C to 400°C with thermocouple safety valve or from 100°C to 280°C with thermostatic valve. Adjustment is from 100°C to 280°C for the chrome version

Technical Data

Dimensions	
Width (mm)	400
Depth (mm)	900
Height (mm)	250
Gas connection (Ø)	-
Electric connection (V/~ /HZ)	-
Cold water connection (Ø)	-
Hot water connection (Ø)	-

Cold soft water connection (Ø)	-
Drain (Ø)	-
Gas power (KW)	7
Electric power (KW)	-
Plate dimensions (mm)	335x700
Tank capacity (Lt)	-
TANK DIMENSIONS	-
Internal ovens dimension(mm)	-

SERIE 900

Code CR0785869 Model 90FT/G400



GAS GRIDDLE WITH SMOOTH PLATE TOP VERSION

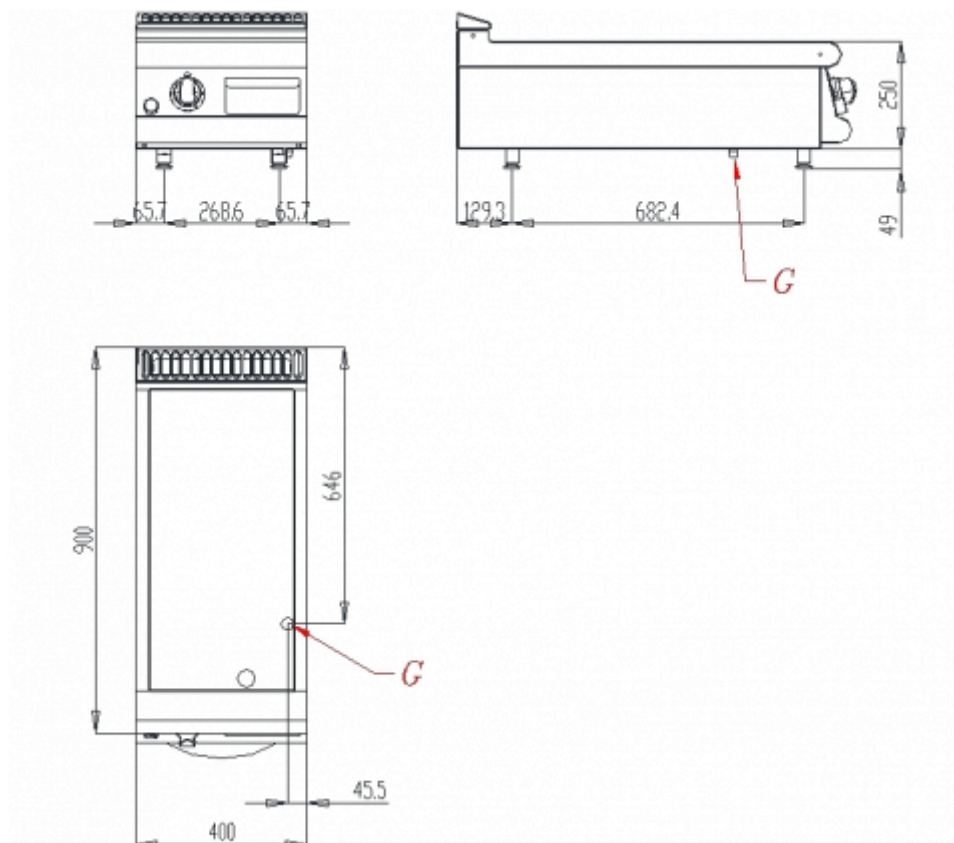

Code	Description
97310000	SCRAPER FOR CHROMIUM SMOOTH PLATE VERSION
8031900340	RIGHT SIDE FINISHING END PIECE FOR 900 LINE
CR0985219	FRY TOP SPLASHBACK W=400
8031900350	LEFT SIDE FINISHING END PIECE FOR 900 LINE
8031900460	FIXED SIDE TOP - RIGHT - 900 SERIE
8031900211	SIDE SUPPORTING TIP TOP - RIGHT - 900 SERIE
8031900470	FIXED SIDE TOP - LEFT - 900 SERIE
8031900221	SIDE SUPPORTING TIP TOP - LEFT - 900 SERIE