



Here your Logo



**NEW**

**EASY-FIT**

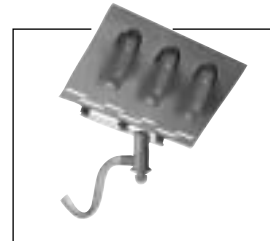

Spray bar quick disconnect

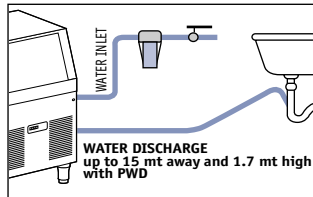

Patented anti-scale system

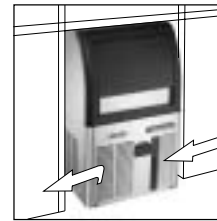

Storage bin antibacterial pouch & holder

- EC 46
- EC 56
- EC 86
- EC 106
- EC 126
- EC 176

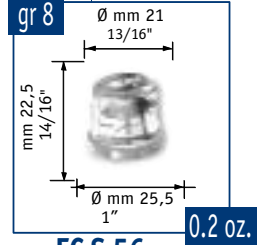

ECS 56

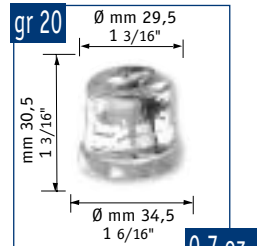

ECM 56

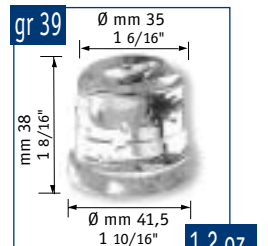

ECL 56



Proximity Condenser air filter



Routine maintenance alarm  
Front ON - OFF switch



Hygienic scoop holder

**Automatic  
Gourmet-Cube  
Ice Machine**

**Machine  
Automatique  
à Glaçons  
Gourmet**

**Automatischer  
Gourmetkegel-  
eisbereiter**

**Màquina  
Automàtica  
Fabricadora de  
Cubitos Gourmet**

**Produttore  
Automatico  
di Ghiaccio a  
Cubetti Gourmet**

| Model     | Temperature Range     | Capacity (Gourmet Cubes) |       |      |      |       |      | Power    | Dimensions (mm) | Dimensions (inches) | Weight  |
|-----------|-----------------------|--------------------------|-------|------|------|-------|------|----------|-----------------|---------------------|---------|
|           |                       | [kg]                     | [lbs] | N°*  | [kg] | [lbs] | N°*  |          |                 |                     |         |
| ECS 56 AS | 10°: 10°C / 21°: 15°C | 25                       | 55    | 3125 | 22.5 | 50    | 2810 | 230/50/1 | 386x600x693/828 | 15"x23"x27"/32"     | R 134 a |
| ECS 56 WS |                       | TBA                      | TBA   | TBA  | TBA  | TBA   | TBA  | 230/50/1 | 386x600x693/828 | 15"x23"x27"/32"     | R 134 a |
| ECM 56 AS |                       | 31.5                     | 69    | 1575 | 29   | 64    | 1450 | 230/50/1 | 386x600x693/828 | 15"x23"x27"/32"     | R 134 a |
| ECM 56 WS |                       | 32.5                     | 72    | 1625 | 29   | 64    | 1450 | 230/50/1 | 386x600x693/828 | 15"x23"x27"/32"     | R 134 a |
| ECL 56 AS |                       | 31                       | 68    | 795  | 28.5 | 63    | 730  | 230/50/1 | 386x600x693/828 | 15"x23"x27"/32"     | R 134 a |
| ECL 56 WS |                       | TBA                      | TBA   | TBA  | TBA  | TBA   | TBA  | 230/50/1 | 386x600x693/828 | 15"x23"x27"/32"     | R 134 a |

\*Estimate number of gourmet cubes. Standard legs 150 mm high included.

[www.scotsman-ice.com](http://www.scotsman-ice.com)  
[www.scotsman-ice.it](http://www.scotsman-ice.it)

**2**

Years Warranty  
Ans de Garantie  
Jahre Garantie  
Años de Garantía  
Anni di Garanzia

Subject to certain limitations and exclusions  
Assujettie aux limites et exclusions prescrites  
Abhängig von Bestimmten Einschränkungen und Ausnahmen  
Sujeta a algunas limitaciones y exclusiones  
Soggetta ad alcune limitazioni ed esclusioni



# EC 56

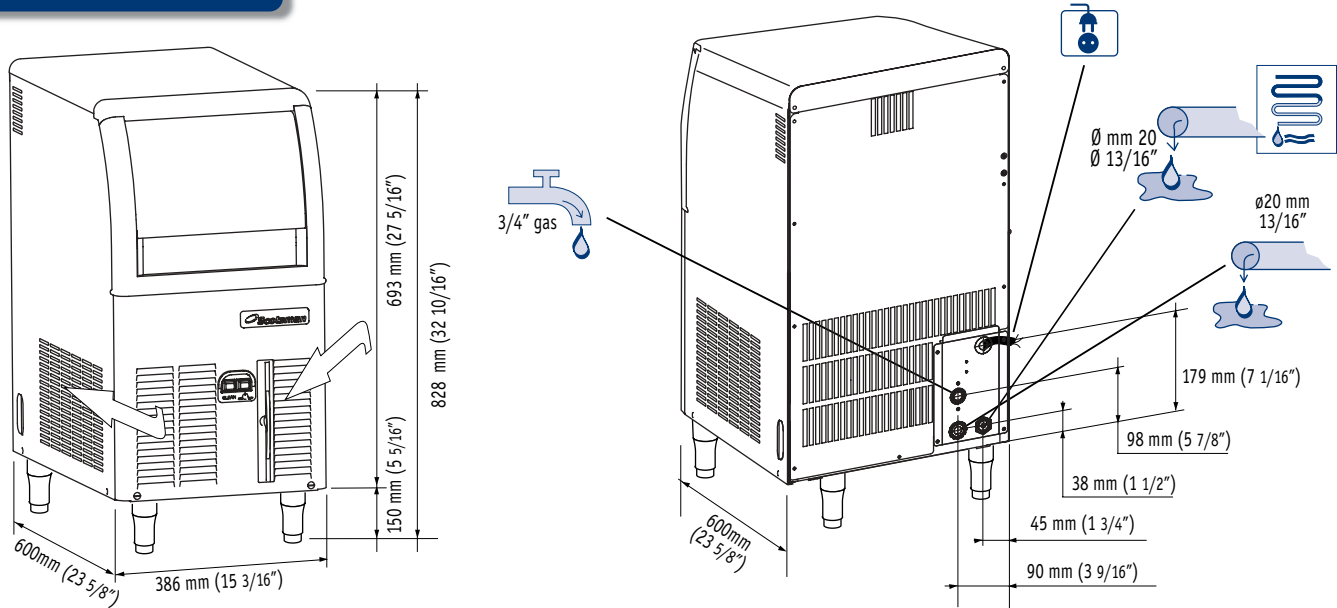

|           |  | -C°<br>+C° | [Btu/h] [W] | [Ømm <sup>2</sup> ] | [W] | FUSE [A] | [kWh] 24h | [L/h] [gal/h] | 32°C F<br>90°F<br>21°C F<br>70°F | [kg] [lbs] | [kg] [lbs] | [kg] [lbs] |  |
|-----------|--|------------|-------------|---------------------|-----|----------|-----------|---------------|----------------------------------|------------|------------|------------|--|
| ECS 56 AS |  |            | 2730 800    | 3x1,5               | 400 | 10       | 7.1       | 3.1 0.82      |                                  | 38 84      | 45 99      |            |  |
| EC 56 WS  |  |            | TBA TBA     | TBA                 | TBA | TBA      | TBA       | TBA TBA       |                                  | TBA TBA    | 45 99      |            |  |
| ECM 56 AS |  |            | 2730 800    | 3x1,5               | 400 | 10       | 7.8       | 3.8 1         |                                  | 38 84      | 45 99      |            |  |
| ECM 56 WS |  |            | 2730 800    | 3x1,5               | 400 | 10       | 7         | 20 5.3        |                                  | 38 84      | 45 99      |            |  |
| ECL 56 AS |  |            | 2730 800    | 3x1,5               | 400 | 10       | 7.6       | 4.2 1.1       |                                  | 38 84      | 45 99      |            |  |
| ECL 56 WS |  |            | TBA TBA     | TBA                 | TBA | TBA      | TBA       | TBA TBA       |                                  | TBA TBA    | TBA TBA    |            |  |

## EC 56 AIR COOLED

## EC 56 WATER COOLED

| °C / °F | 50°<br>10° | 60°<br>15° | 70°<br>21° | 90°<br>32° |     |
|---------|------------|------------|------------|------------|-----|
| 10°     | 31.5       | 30         | 28.5       | 25.5       | kg  |
| 50°     | 69.5       | 66         | 63         | 56         | lbs |
| 21°     | 30.5       | 29         | 27.5       | 24.5       | kg  |
| 70°     | 67         | 64         | 60.5       | 54         | lbs |
| 32°     | 27         | 25.5       | 24         | 21         | kg  |
| 90°     | 59.5       | 56         | 53         | 46         | lbs |
| 38°     | 25.5       | 24         | 22.5       | 19.5       | kg  |
| 100     | 56         | 53         | 50         | 43         | lbs |

| °C / °F | 50°<br>10° | 60°<br>15° | 70°<br>21° | 90°<br>32° |     |
|---------|------------|------------|------------|------------|-----|
| 10°     | 32.5       | 31         | 29.5       | 26.5       | kg  |
| 50°     | 72         | 68         | 65         | 58         | lbs |
| 21°     | 30.5       | 29         | 27.5       | 24.5       | kg  |
| 70°     | 67         | 64         | 61         | 54         | lbs |
| 32°     | 30         | 28.5       | 27         | 24         | kg  |
| 90°     | 66         | 63         | 59.5       | 53         | lbs |
| 38°     | 29         | 27.5       | 26         | 23         | kg  |
| 100     | 64         | 61         | 57         | 51         | lbs |

| Minimum         | Maximum         |
|-----------------|-----------------|
| 10°C (50°F)     | 40°C (104°F)    |
| 5°C (41°F)      | 35°C (95°F)     |
| -10%            | +10%            |
| 1 BAR<br>14 psi | 5 BAR<br>70 psi |

Machine requires voltage indicated on rating name plate. Failures caused by improper voltage are not considered factory defects. Scotsman products are not designed for outdoor installation. Extended periods of operation at temperatures exceeding the above limitations constitutes misuse under the terms of Scotsman Limited Warranty, resulting in a loss.

La machine doit être raccordée conformément au voltage indiqué sur la plaque signalétique. Les éventuels dégâts causés par un non respect de cette consigne ne peuvent être considérés comme des défauts de fabrication. Les machines à glace Scotsman ne sont pas conçues pour être utilisées à l'extérieur. Le fonctionnement prolongé à des températures supérieures ou inférieures aux limites ci-dessus sont considérées comme une mauvaise utilisation dans le cadre de la garantie Scotsman.

Der Eisbereiter benötigt eine Stromspannung gemäß Geräte-Typenschild. Störungen oder Ausfälle, durch den Betrieb mit falscher Stromspannung sind keine Fabrikationsfehler und fallen nicht unter Garantie. Scotsman Eisbereiter sind nicht für die Installation im Freien geeignet. Der längere Betrieb bei Temperaturen über den obigen Grenzwerten ist eine falsche Anwendung und bedeutet den Verlust der Garantieleistung.

Los requerimientos eléctricos de la máquina están indicados en la placa de características. Los daños causados por voltajes inadecuados no son considerados defectos de fábrica. La máquina de hielo Scotsman, no están diseñadas para trabajar a la intemperie. Largos periodos de funcionamiento a temperaturas que excedan de las limitaciones indicadas, constituyen maltrato de acuerdo con las observaciones de Scotsman.

La macchina richiede il voltaggio indicato sulla targhetta di identificazione. Danni causati da voltaggi diversi non sono considerati difetti di produzione. I prodotti Scotsman non vanno utilizzati all'aperto. Un prolungato periodo di utilizzo al di fuori delle temperature indicate non è consentito e causa l'automatico decadere della garanzia.



**Certified ISO 9001:2000**

|  |   |  |  |   |   |
|--|---|--|--|---|---|
| <p><b>USA, Canada, Latin America</b><br/>Scotsman Ice Systems USA<br/>775 Corporate Woods Parkway<br/>Vernon Hills, IL 60061<br/>Ph: (+1) 847 215-4550<br/>Fax (+1) 847 913-9844<br/>customer.service@scotsman-ice.com</p> | <p><b>Europe</b><br/>Scotsman Europe-Frimont S.p.A.<br/>Via Puccini, 22<br/>20010 Pogliano (Milano) Italy<br/>Ph: (+39) 02-93960208<br/>Fax: (+39) 02-93960201<br/>scotsman.europe@frimont.it</p> | <p><b>Asia and Pacific</b><br/>Scotsman Ice Systems-Frimont S.p.A. (R.O.)<br/>627A Aljunied Road-#04-04 Biztech Centre<br/>Singapore 389842<br/>Ph: (+65) 6738 5393<br/>Fax: (+65) 6738 1959<br/>scotsice@singnet.com.sg</p> | <p><b>China</b><br/>Scotsman Ice Systems (Shanghai) Co. Ltd<br/>613 Kaixuan Road, Building G<br/>Shanghai, China 200051<br/>Ph: +86-2161526100 - Fax: +86-2161526020<br/>sales@enodis.com.cn<br/>service@enodis.com.cn</p> | <p><b>Middle East &amp; N. Africa</b><br/>Scotsman Ice Systems Dubai Office<br/>P.o. Box 21648<br/>Sharjah - U.A.E.<br/>Ph: (+971) 65773164<br/>Fax (+971) 65773165<br/>scotsman@eim.ae</p> | <p><b>South Africa</b><br/>Scotsman Ice Systems SA (PTY) Ltd.<br/>10, Rhodes Street - Kensington B<br/>P.o. Box 44 - Riverclub 2149<br/>Ph: (+27) 11-7898400<br/>Fax (+27) 11-7898411<br/>scotsman@telkomsa.net</p> |
|--|---|--|--|---|---|